



Is Now Part of



ON Semiconductor®

To learn more about ON Semiconductor, please visit our website at
www.onsemi.com

ON Semiconductor and the ON Semiconductor logo are trademarks of Semiconductor Components Industries, LLC dba ON Semiconductor or its subsidiaries in the United States and/or other countries. ON Semiconductor owns the rights to a number of patents, trademarks, copyrights, trade secrets, and other intellectual property. A listing of ON Semiconductor's product/patent coverage may be accessed at www.onsemi.com/site/pdf/Patent-Marking.pdf. ON Semiconductor reserves the right to make changes without further notice to any products herein. ON Semiconductor makes no warranty, representation or guarantee regarding the suitability of its products for any particular purpose, nor does ON Semiconductor assume any liability arising out of the application or use of any product or circuit, and specifically disclaims any and all liability, including without limitation special, consequential or incidental damages. Buyer is responsible for its products and applications using ON Semiconductor products, including compliance with all laws, regulations and safety requirements or standards, regardless of any support or applications information provided by ON Semiconductor. "Typical" parameters which may be provided in ON Semiconductor data sheets and/or specifications can and do vary in different applications and actual performance may vary over time. All operating parameters, including "Typicals" must be validated for each customer application by customer's technical experts. ON Semiconductor does not convey any license under its patent rights nor the rights of others. ON Semiconductor products are not designed, intended, or authorized for use as a critical component in life support systems or any FDA Class 3 medical devices or medical devices with a same or similar classification in a foreign jurisdiction or any devices intended for implantation in the human body. Should Buyer purchase or use ON Semiconductor products for any such unintended or unauthorized application, Buyer shall indemnify and hold ON Semiconductor and its officers, employees, subsidiaries, affiliates, and distributors harmless against all claims, costs, damages, and expenses, and reasonable attorney fees arising out of, directly or indirectly, any claim of personal injury or death associated with such unintended or unauthorized use, even if such claim alleges that ON Semiconductor was negligent regarding the design or manufacture of the part. ON Semiconductor is an Equal Opportunity/Affirmative Action Employer. This literature is subject to all applicable copyright laws and is not for resale in any manner.

KA78RXXC-Series

1A Output Low Dropout Voltage Regulators

Features

- 1A/3.3V, 5V, 8V, 9V, 12V, 15V output low dropout voltage regulator
- TO-220 full-mold package (4pin)
- Overcurrent protection, thermal shutdown
- Overvoltage protection, short circuit protection
- With output disable function

Description

The KA78RXXC is a low-dropout voltage regulator suitable for various electronic equipments.

It provides constant voltage power source with TO-220-4 lead full mold package. Dropout voltage of KA78RXXC is below 0.5V in full rated current(1A).

This regulator has various functions such as peak current protection, thermal shut down, overvoltage protection and output disable function.

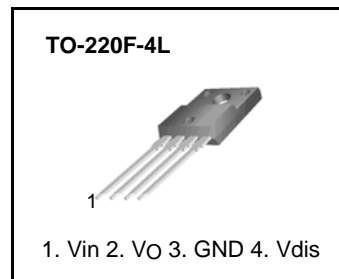

Internal Block Diagram

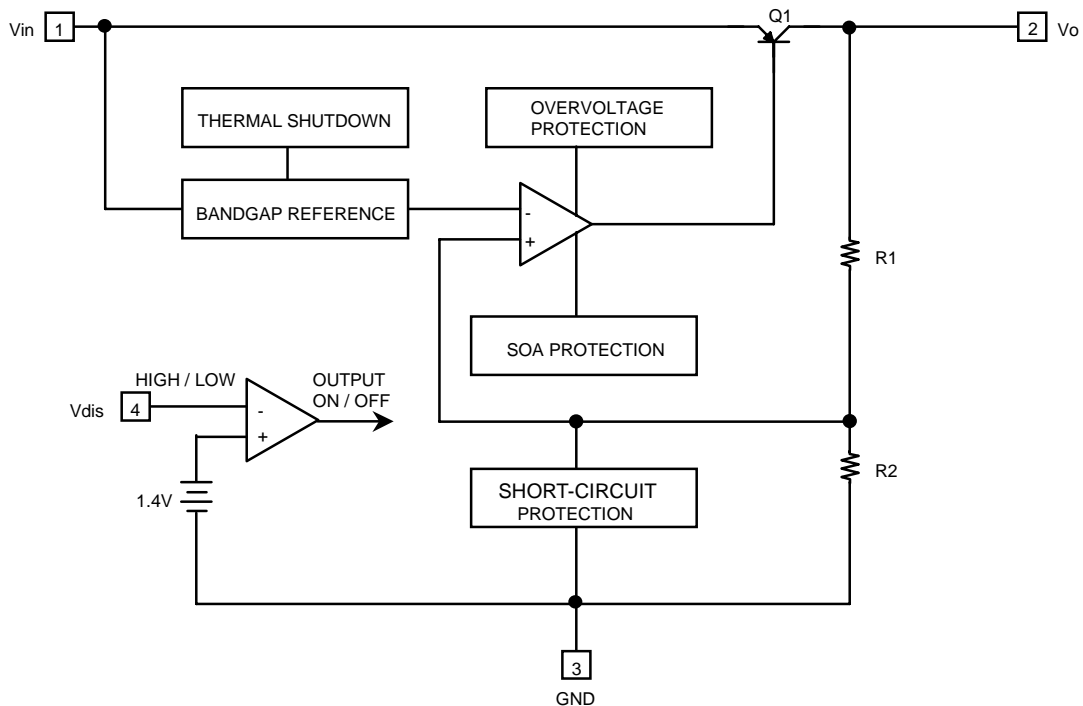

Absolute Maximum Ratings

KA78RXXC

Parameter	Symbol	Value	Unit	Remark
Input voltage	V _{in}	35	V	-
Disable voltage	V _{dis}	35	V	-
Output current	I _o	1.0	A	-
Power dissipation 1	P _{d1}	1.5	W	No heatsink
Power dissipation 2	P _{d2}	15	W	With heatsink
Junction temperature	T _j	+150	°C	-
Operating temperature	T _{opr}	-20 ~ +80	°C	-
Thermal resistance, junction-to case (Note2)	R _{θjc}	4.31	°C/W	-
Thermal resistance, junction-to-air (Note2)	R _{θja}	48.83	°C/W	-

Electrical Characteristics

(V_{in} = Note3, I_o = 0.5A, T_a = 25°C, unless otherwise specified)

Parameter	Symbol	Conditions	Min.	Typ.	Max.	Unit
Output voltage	KA78R33C	-	3.22	3.3	3.38	V
	KA78R05C	-	4.88	5	5.12	
	KA78R08C	-	7.8	8	8.2	
	KA78R09C	-	8.78	9	9.22	
	KA78R12C	-	11.7	12	12.3	
	KA78R15C	-	14.6	15	15.4	
Load regulation	Rload	5mA < I_o < 1A	-	0.1	2.0	%
Line regulation	Rline	Note4	-	0.5	2.5	%
Ripple rejection ratio	RR	Note1	45	55	-	dB
Dropout voltage	Vdrop	I_o = 1A	-	-	0.5	V
Disable voltage high	VdisH	Output active	2.0	-	-	V
Disable voltage low	VdisL	Output disabled	-	-	0.8	V
Disable bias current high	IdisH	Vdis = 2.7V	-	-	20	μA
Disable bias current low	IdisL	Vdis = 0.4V	-	-	-0.4	mA
Quiescent current	Iq	I_o = 0A	-	-	10	mA

Note:

- These parameters, although guaranteed, are not 100% tested in production.
- Junction -to -case thermal resistance test environments.
 - Pneumatic heat sink fixture.
 - Clamping pressure 60psi through 12mm diameter cylinder.
 - Thermal grease applied between PKG and heat sink fixture.
- KA78R33C : V_{in} = 5V
 KA78R05C : V_{in} = 7V
 KA78R08C : V_{in} = 10V
 KA78R09C : V_{in} = 11V
 KA78R12C : V_{in} = 15V
 KA78R15C : V_{in} = 20V
- KA78R33C : V_{in} = 4V to 10V
 KA78R05C : V_{in} = 6V to 12V
 KA78R08C : V_{in} = 9V to 25V
 KA78R09C : V_{in} = 10V to 25V
 KA78R12C : V_{in} = 13V to 29V
 KA78R15C : V_{in} = 16V to 30V

Typical Performance Characteristics

KA78R33

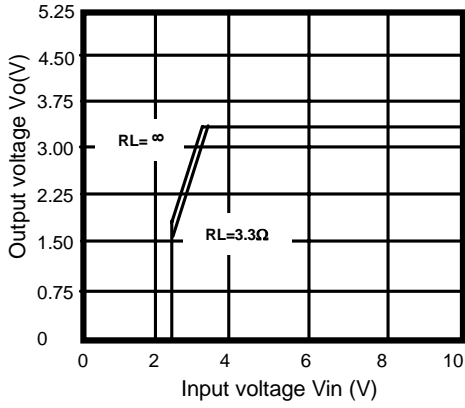

Figure 1. Output Voltage vs. Input Voltage

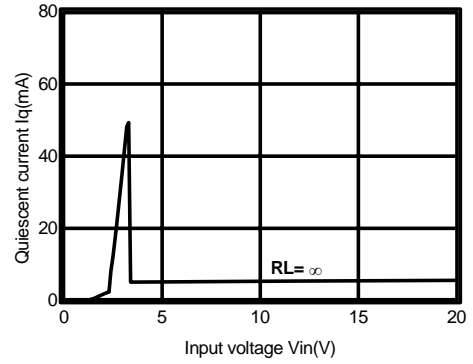

Figure 2. Quiescent Current vs. Input Voltage

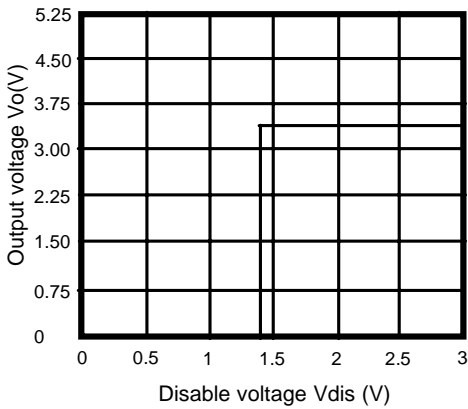

Figure 3. Output Voltage vs. Disable Voltage

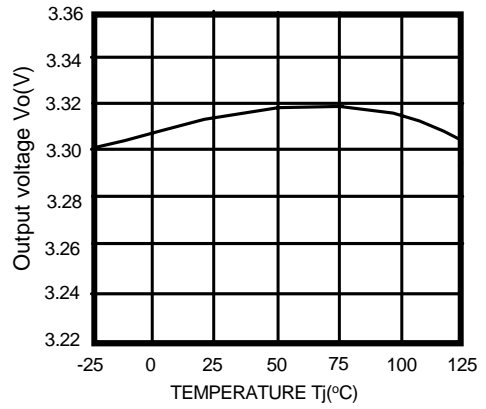

Figure 4. Output Voltage vs. Temperature(Tj)

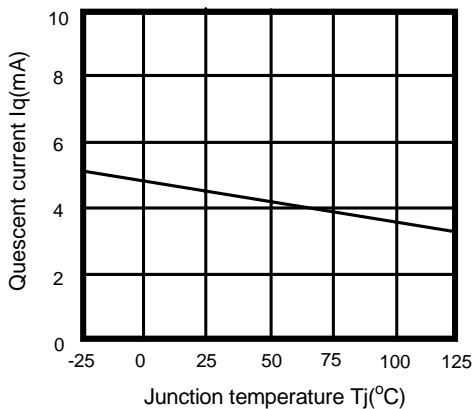

Figure 5. Quiescent Current vs. Temperature(Tj)

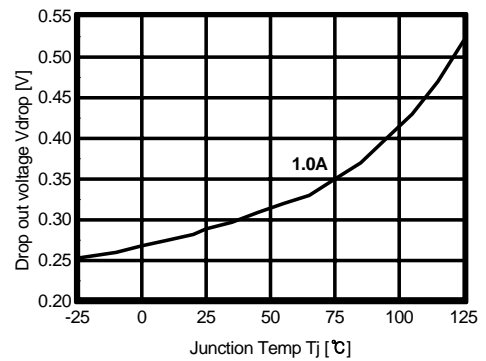

Figure 6. Dropout Voltage vs. Junction Temperature

Typical Performance Characteristics (Continued)

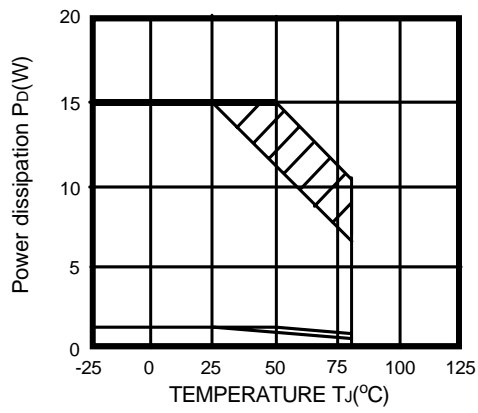

Figure 7. Power Dissipation vs. Temperature(T_j)

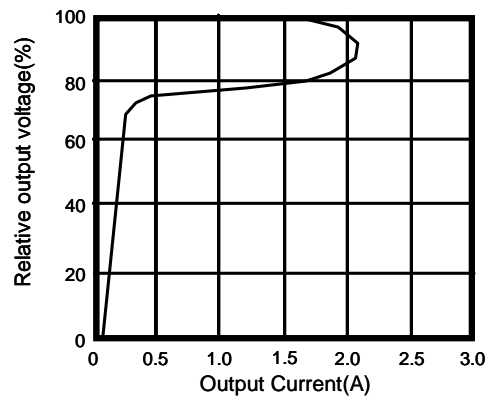

Figure 8. Overcurrent Protection Characteristics (Typical Value)

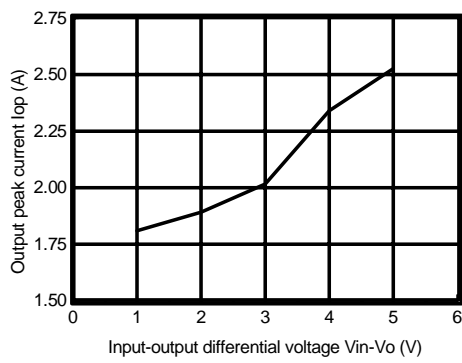

Figure 9. Output Peak Current vs. Input-Output Differential Voltage

Typical Performance Characteristics

KA78R05C

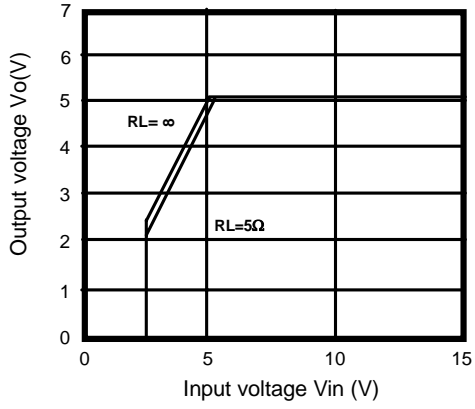

Figure 1. Output Voltage vs. Input Voltage

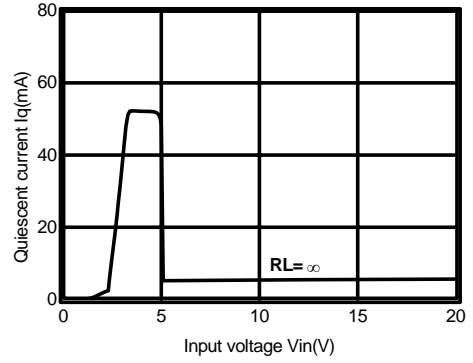

Figure 2. Quiescent Current vs. Input Voltage

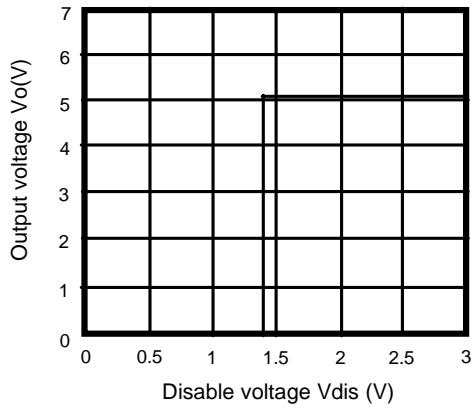

Figure 3. Output Voltage vs. Disable Voltage

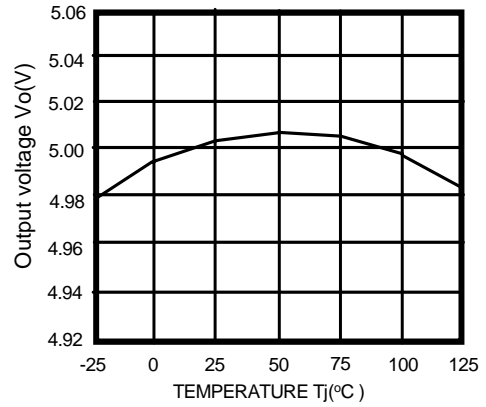

Figure 4. Output Voltage vs. Temperature(Tj)

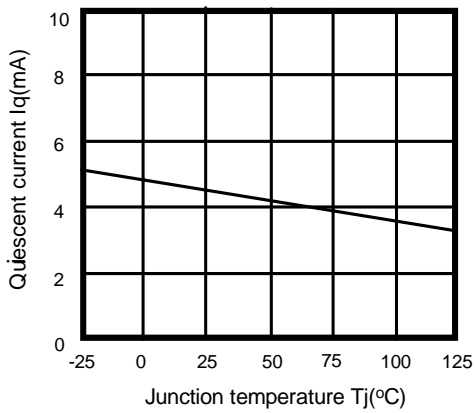

Figure 5. Quiescent Current vs. Temperature(Tj)

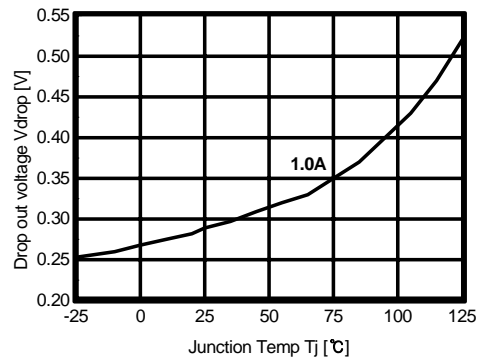

Figure 6. Dropout Voltage vs. Junction Temperature

Typical Performance Characteristics (Continued)

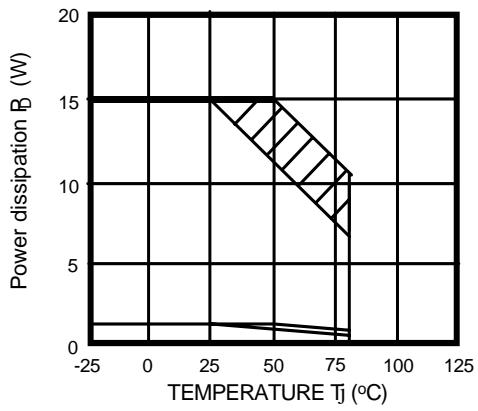

Figure 7. Power Dissipation vs. Temperature(T_j)

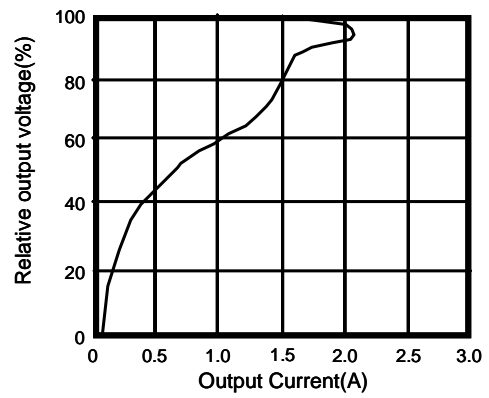

Figure 8. Overcurrent Protection Characteristics (Typical Value)

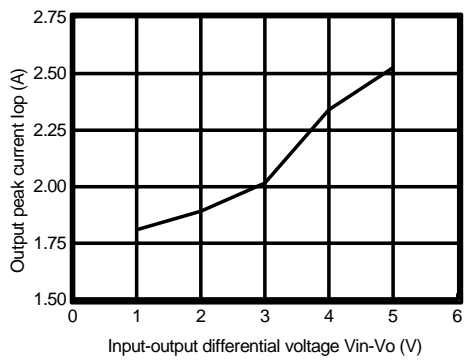

Figure 9. Output Peak Current vs. Input-Output Differential Voltage

Typical Performance Characteristics (Continued)

KA78R08C

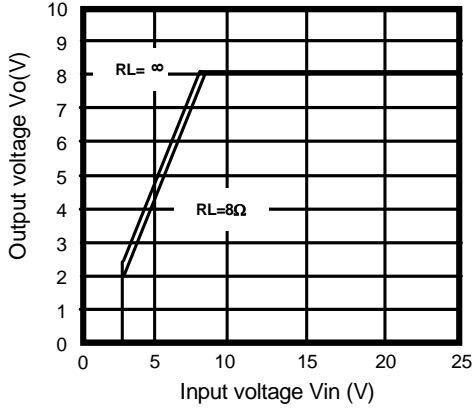

Figure 1. Output Voltage vs. Input Voltage

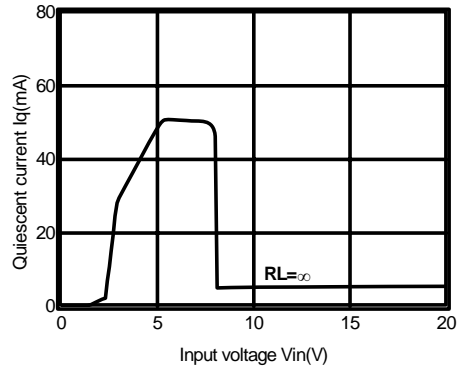

Figure 2. Quiescent Current vs. Input Voltage

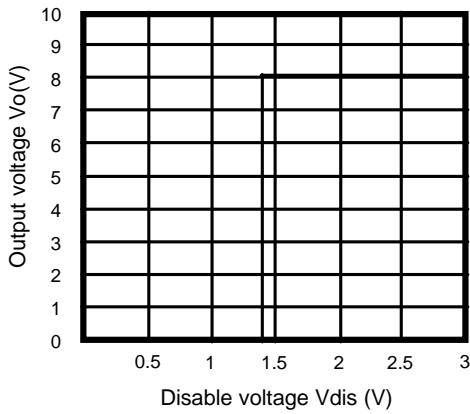

Figure 3. Output Voltage vs. Disable Voltage

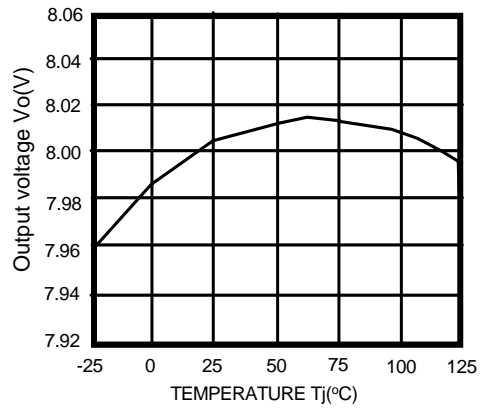

Figure 4. Output Voltage vs. Temperature(Tj)

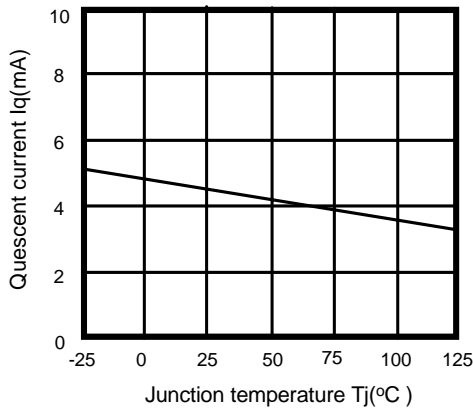

Figure 5. Quiescent Current vs. Temperature(Tj)

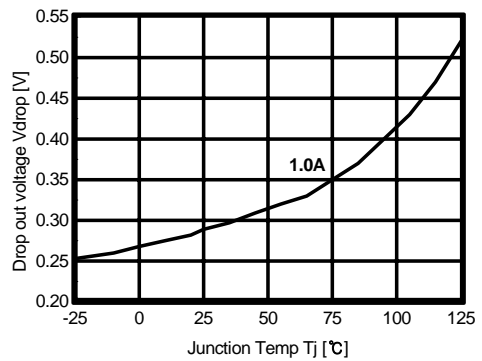

Figure 6. Dropout Voltage vs. Junction Temperature

Typical Performance Characteristics (Continued)

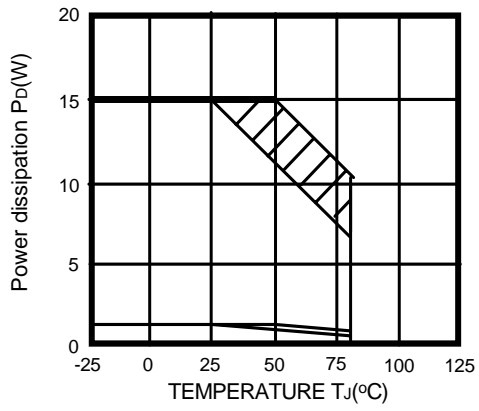

Figure 7. Power Dissipation vs. Temperature(T_j)

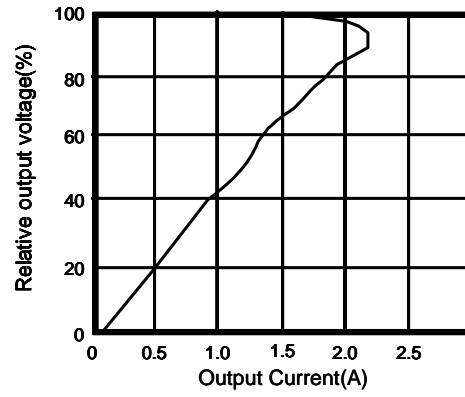

Figure 8. Overcurrent Protection Characteristics (Typical Value)

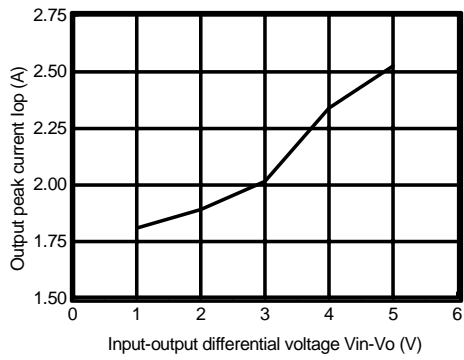

Figure 9. Output Peak Current vs. Input-Output Differential Voltage

Typical Performance Characteristics (Continued)

KA78R09C

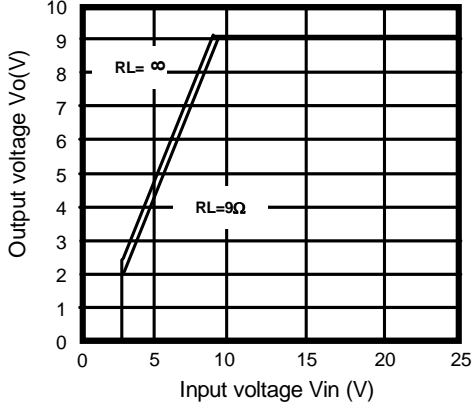

Figure 1. Output Voltage vs. Input Voltage

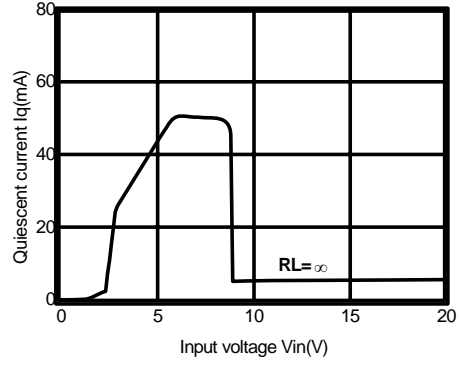

Figure 2. Quiescent Current vs. Input Voltage

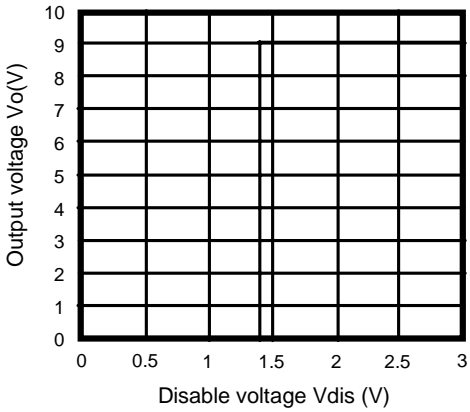

Figure 3. Output Voltage vs. Disable Voltage

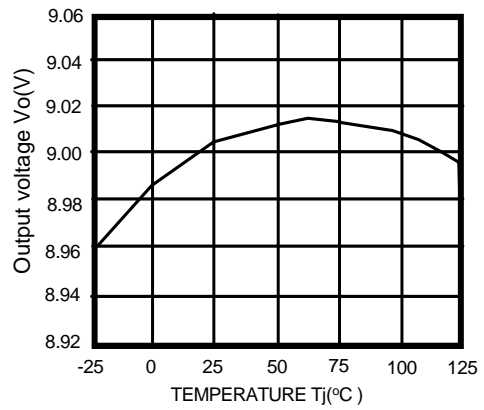

Figure 4. Output Voltage vs. Temperature(T_j)

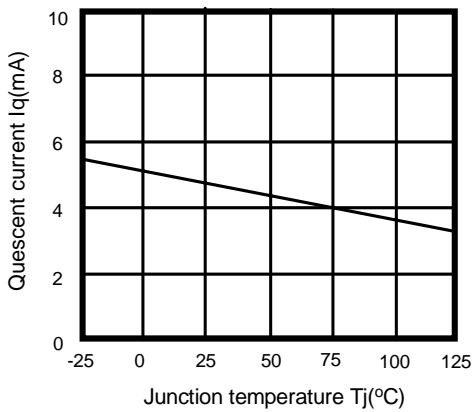

Figure 5. Quiescent Current vs. Temperature(T_j)

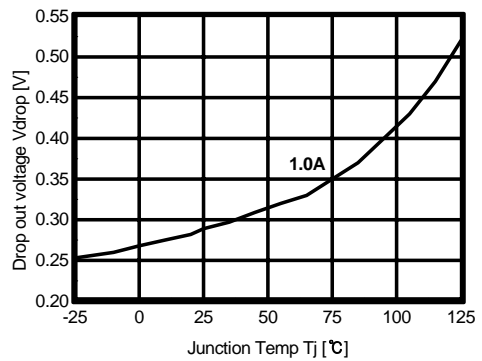

Figure 6. Dropout Voltage vs. Junction Temperature

Typical Performance Characteristics (Continued)

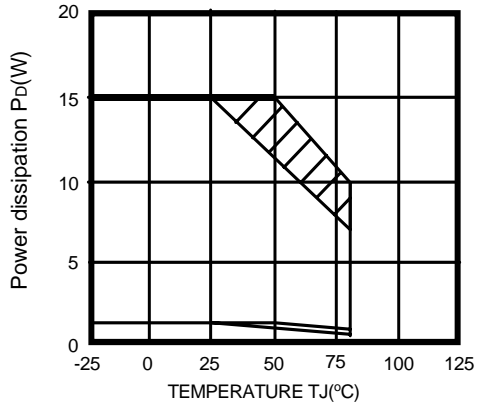

Figure 7. Power Dissipation vs. Temperature(Tj)

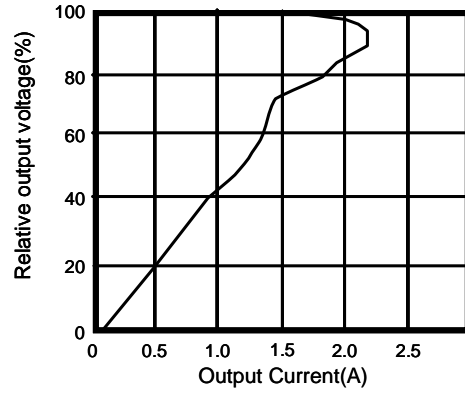

Figure 8. Overcurrent Protection Characteristics (Typical Value)

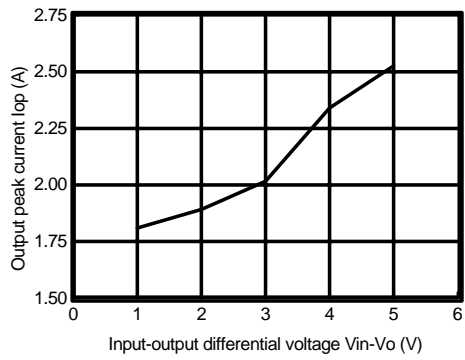

Figure 9. Output Peak Current vs. Input-Output Differential Voltage

Typical Performance Characteristics (Continued)

KA78R12C

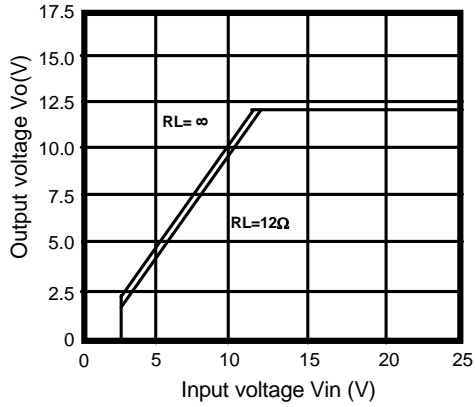

Figure 1. Output Voltage vs. Input Voltage

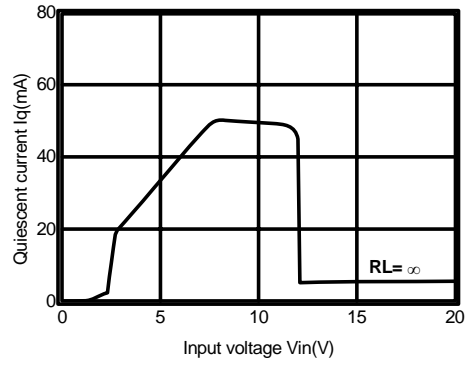

Figure 2. Quiescent Current vs. Input Voltage

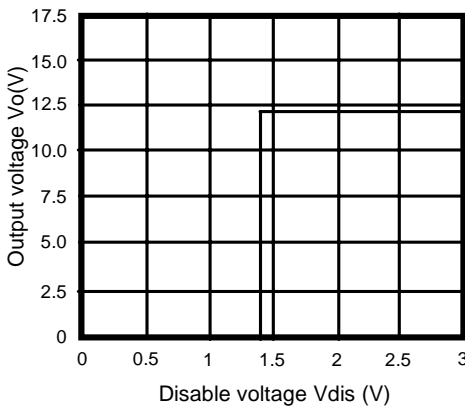

Figure 3. Output Voltage vs. Disable Voltage

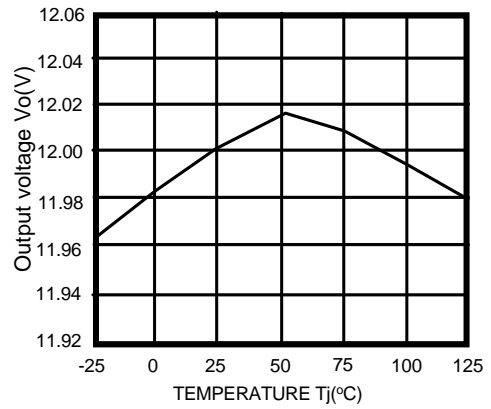

Figure 4. Output Voltage vs. Temperature(Tj)

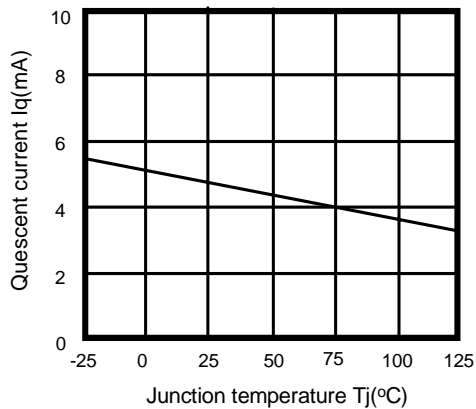

Figure 5. Quiescent Current vs. Temperature(Tj)

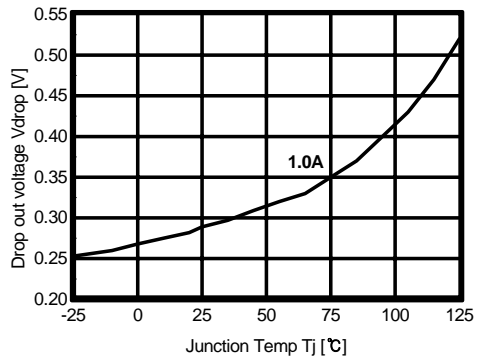

Figure 6. Dropout Voltage vs. Junction Temperature

Typical Performance Characteristics (Continued)

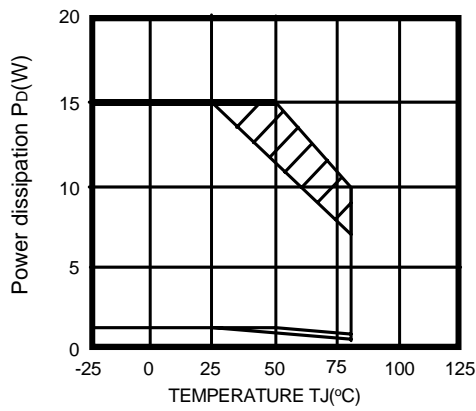

Figure 7. Power Dissipation vs. Temperature(T_J)

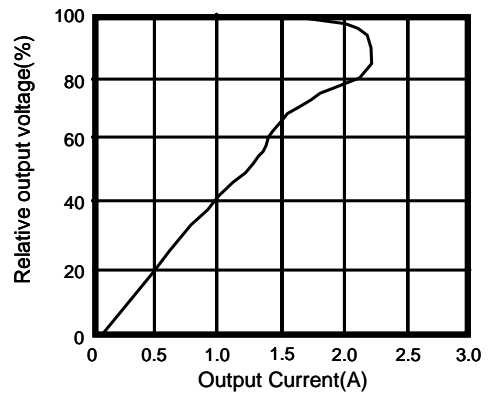

Figure 8. Overcurrent Protection Characteristics (Typical Value)

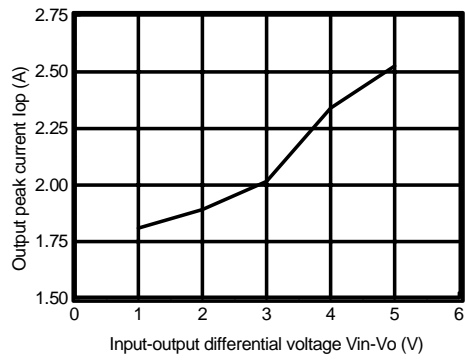

Figure 9. Output Peak Current vs. Input-Output Differential Voltage

Typical Performance Characteristics (Continued)

KA78R15C

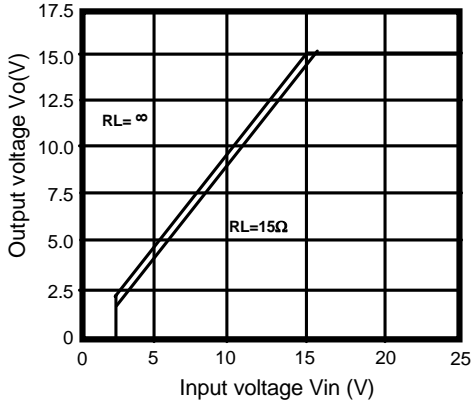

Figure 1. Output Voltage vs. Input Voltage

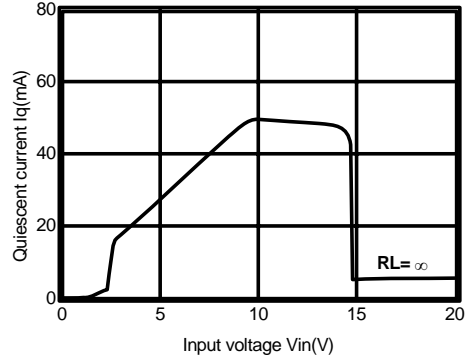

Figure 2. Quiescent Current vs. Input Voltage

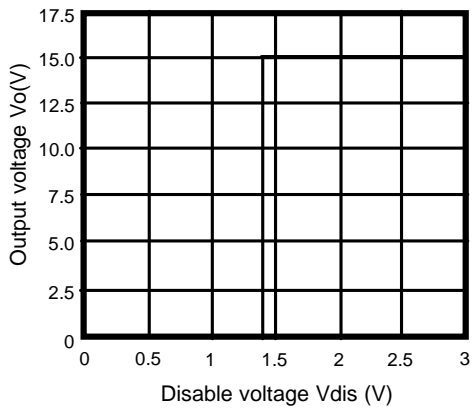

Figure 3. Output Voltage vs. Disable Voltage

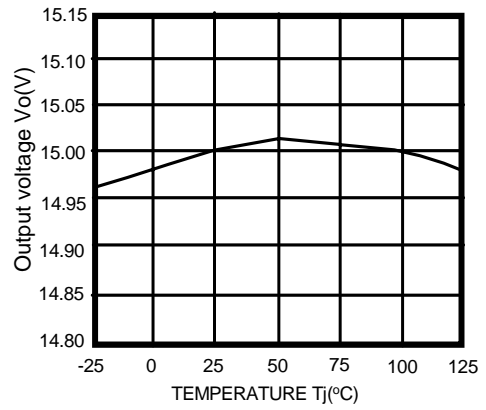

Figure 4. Output Voltage vs. Temperature(Tj)

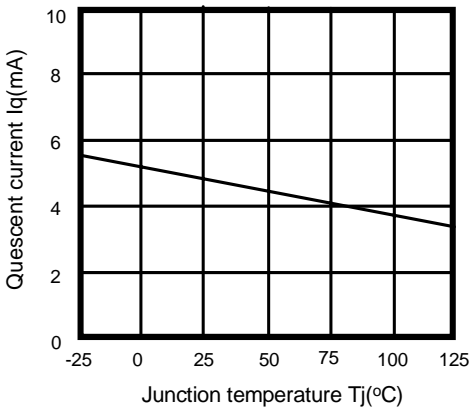

Figure 5. Quiescent Current vs. Temperature(Tj)

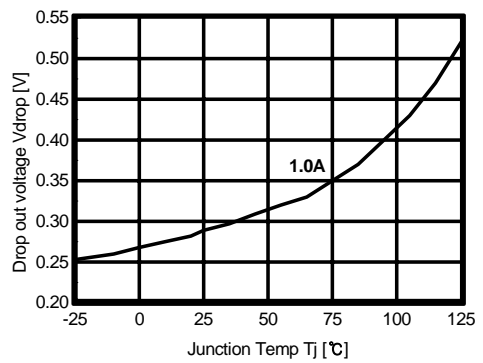

Figure 6. Dropout Voltage vs. Junction Temperature

Typical Performance Characteristics (Continued)

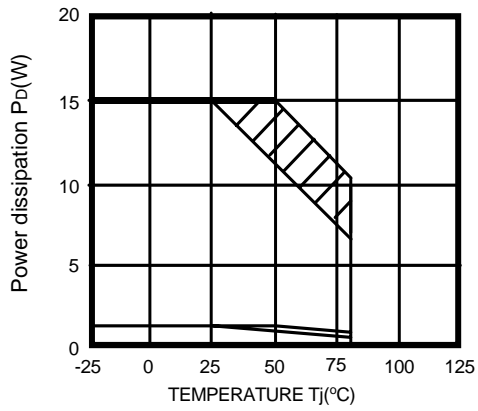

Figure 7. Power Dissipation vs. Temperature(T_j)

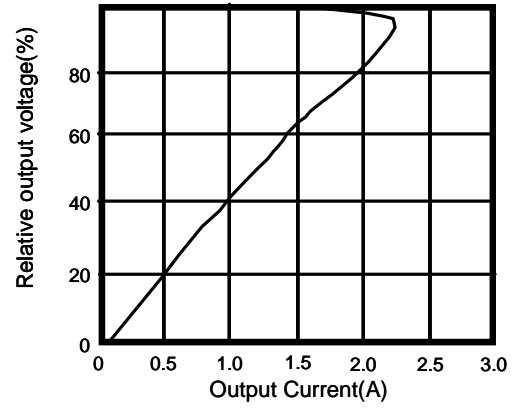

Figure 8. Overcurrent Protection Characteristics (Typical Value)

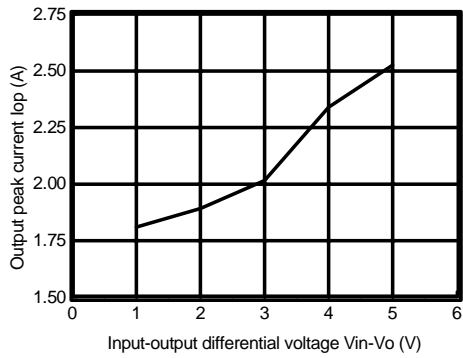

Figure 9. Output Peak Current vs. Input-Output Differential Voltage

Typical Application

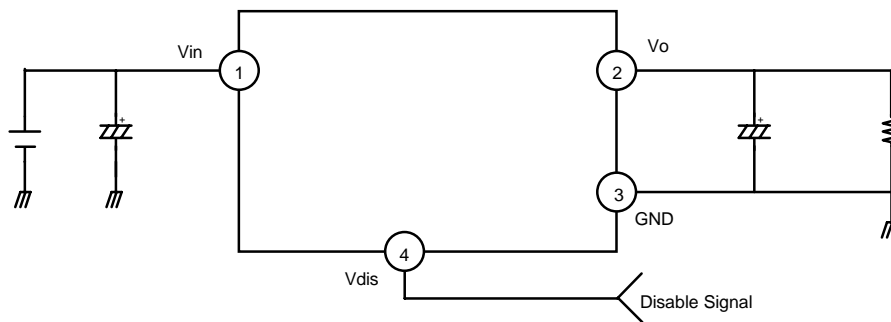

Figure 1. Application Circuit

- C_i is required if regulator is located at an appreciable distance from power supply filter.
- C_o improves stability and transient response. ($C_o > 47\mu\text{F}$)

Mechanical Dimensions

Package

Dimensions in millimeters

TO-220F-4L

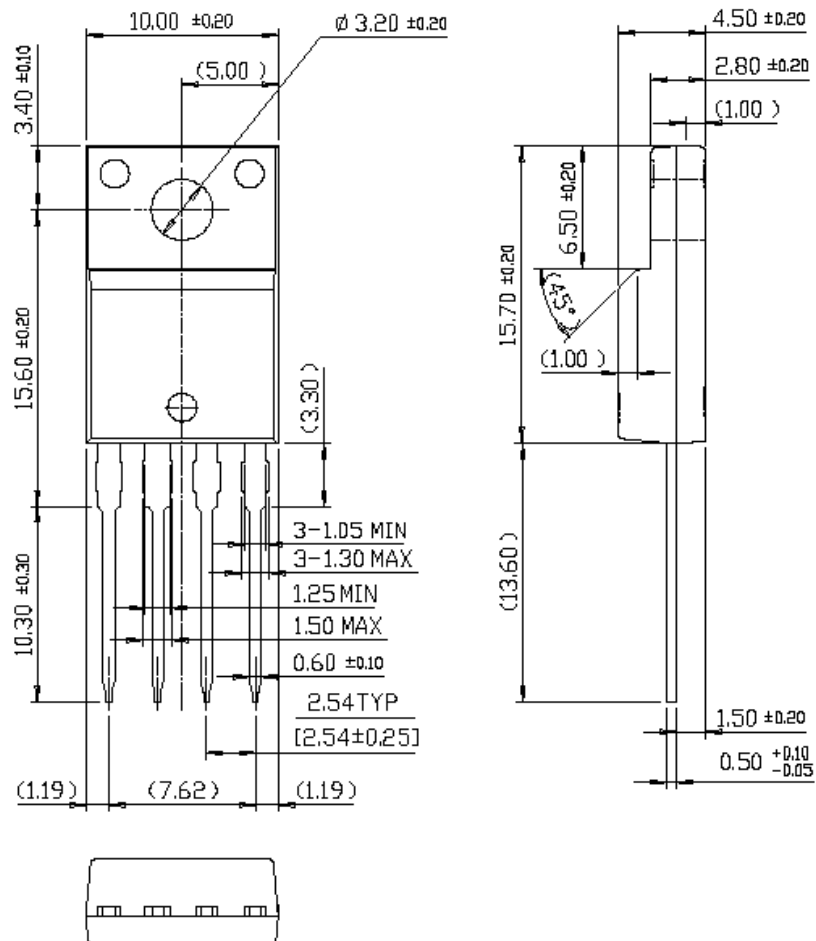

Ordering Information

Product Number	Package	Operating Temperature
KA78R33CTU	TO-220F-4L	-20°C to +80°C
KA78R05CTU		
KA78R08CTU		
KA78R09CTU		
KA78R12CTU		
KA78R15CTU		

DISCLAIMER

FAIRCHILD SEMICONDUCTOR RESERVES THE RIGHT TO MAKE CHANGES WITHOUT FURTHER NOTICE TO ANY PRODUCTS HEREIN TO IMPROVE RELIABILITY, FUNCTION OR DESIGN. FAIRCHILD DOES NOT ASSUME ANY LIABILITY ARISING OUT OF THE APPLICATION OR USE OF ANY PRODUCT OR CIRCUIT DESCRIBED HEREIN; NEITHER DOES IT CONVEY ANY LICENSE UNDER ITS PATENT RIGHTS, NOR THE RIGHTS OF OTHERS.

LIFE SUPPORT POLICY

FAIRCHILD'S PRODUCTS ARE NOT AUTHORIZED FOR USE AS CRITICAL COMPONENTS IN LIFE SUPPORT DEVICES OR SYSTEMS WITHOUT THE EXPRESS WRITTEN APPROVAL OF THE PRESIDENT OF FAIRCHILD SEMICONDUCTOR CORPORATION. As used herein:

1. Life support devices or systems are devices or systems which, (a) are intended for surgical implant into the body, or (b) support or sustain life, and (c) whose failure to perform when properly used in accordance with instructions for use provided in the labeling, can be reasonably expected to result in a significant injury of the user.
2. A critical component in any component of a life support device or system whose failure to perform can be reasonably expected to cause the failure of the life support device or system, or to affect its safety or effectiveness.

Mouser Electronics

Authorized Distributor

Click to View Pricing, Inventory, Delivery & Lifecycle Information:

[Fairchild Semiconductor:](#)

[KA78R08CTU](#)